

TOMOE®

Excellence through hydrodynamics

COMPANY PROFILE



TOMOE VALVE CO., LTD. www.tomoevalve.com

© Head Office
3-11-11 Shinmachi, Nishi-ku, Osaka 550-0013, Japan
Telephone: +81-6-6110-2101/2102/2103 Telefax: +81-6-6110-2105/2106 E-mail: sales@tomoevalve.com

Global Sales Operations

SHANGHAI TOMOE VALVE CO., LTD.

No.2755 Bao An Road, Malu Town, Jiading District Shanghai, 201801, CHINA.
Telephone: +86-21-69155067 Telefax: +86-21-69155068

TOMOE VALVE ASIA PACIFIC PTE. LTD. www.tomoe.com.sg/index.php

Blk 8 Chia Ping Road #07-11 Singapore 619973
Telephone: +65-68995060 Telefax: +65-68995061 E-mail: sales@tomoe.com.sg

TOMOE VALVE LIMITED www.tomoeurope.co.uk

Clearwater Road, Queensway Meadows Industrial Estate, Newport, South Wales NP19 4ST, United Kingdom
Telephone: +44-1633-636800 Telefax: +44-1633-636801 E-mail: sales@tomoe.co.uk

TOMOE USA Inc.

14411 Inter Drive West, Houston, Texas, 77032, USA
Telephone: +1-281-351-7571 Telefax: +1-281-358-7861

PT. TOMOE VALVE BATAM www.tomoe-batam.com

Block F2 Latrade Industrial Park, Tanjung Uncang, Batam Kepulauan Rian 29422, Indonesia
Telephone: +62-778-395466 Telefax: +62-778-396475

Cat.No.EX007-② 2014.07.07-Pn

TOMOE VALVE CO., LTD.

AT THE FRONTIER OF FLOW CONTROL TECHNOLOGY

TOMOE has pioneered the development of butterfly valve technology for more than 50 years. Established in 1953 in Japan with a single-minded commitment to research and development, our dedication to developing products that continue to satisfy the sophisticated demands of process industries today has earned us a reputation for supplying one of the finest and most comprehensive ranges of process control valves and actuators in the world.

TOMOE valves can be found operating in a vast range of industries worldwide including oil & gas, petrochemical, marine, water treatment, food processing, vehicle manufacture and power generation. Our products are renowned for providing leak-tight solutions that make a positive contribution to plant efficiency, backed by a total commitment to customer service and support.

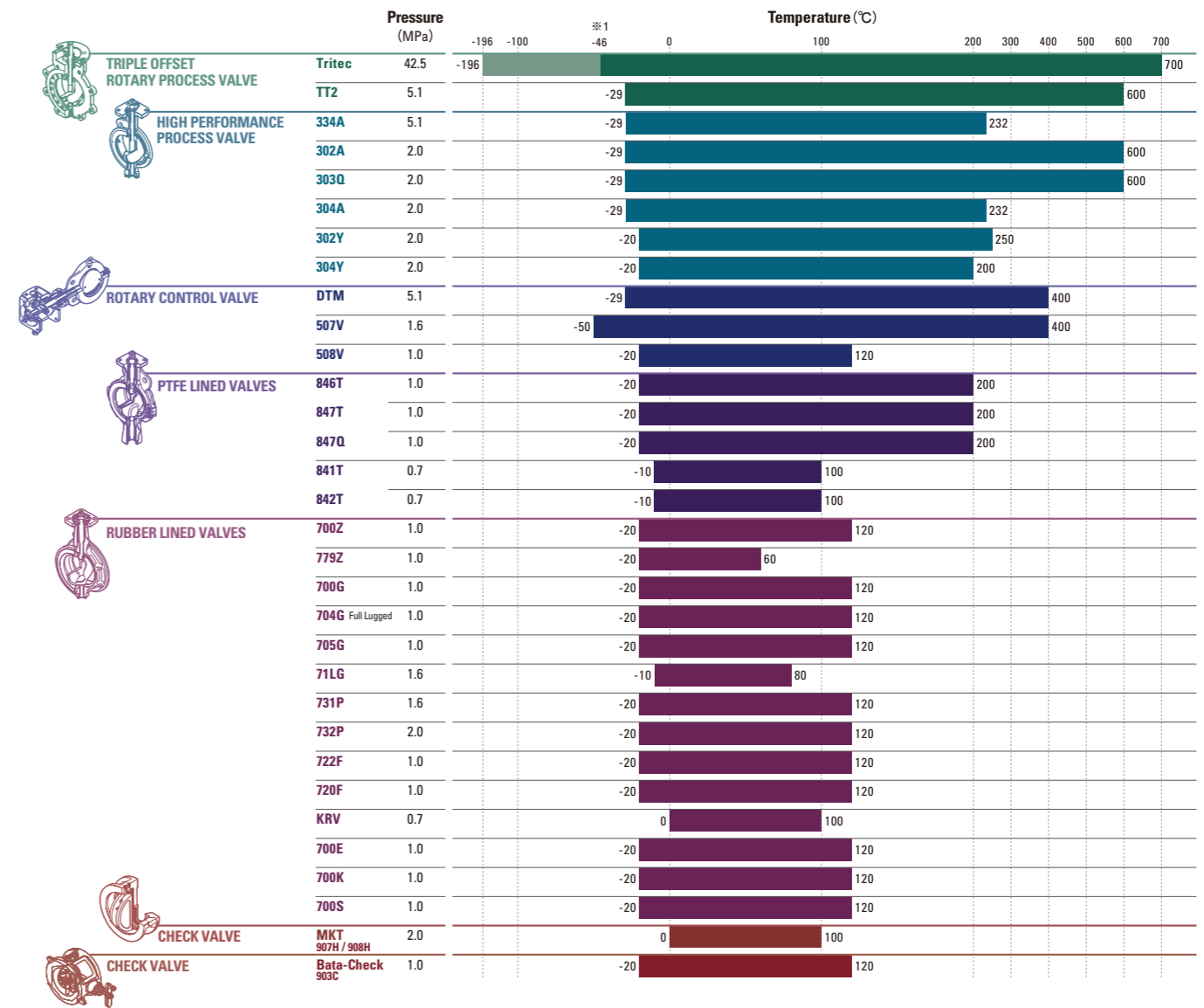

※1 -46°C service for Tritec is available with suitable material. Please consult our sales for the service condition lower than -46°C.

● Please contact us for detailed information.

GROUP PROFILE

Since its formation in Osaka in 1953, TOMOE has designed and developed a high quality and technically advanced range of butterfly valves, actuators, and control systems. Through extensive commitment to Research & Development, TOMOE continues to be the leading company in the development of these products, both in utilising the latest materials technology and sustaining consistently high levels of product performance.

The TOMOE range is now recognised as one of the finest, most comprehensive and reliable ranges in the world, backed by a global network of TOMOE Group companies and distributors delivering top quality service and customer support.

Our valves can be found providing unsurpassed levels of leak tightness and wear resistance on every continent and in almost every industry worldwide including:

- Water Treatment
- Chemical Processing
- Food & Drink
- Sugar Processing
- Oil and Gas
- Off shore
- Petrochemical
- HVAC
- Power Generation
- LNG
- Iron and Steel
- Marine
- Cement
- Powder Handling

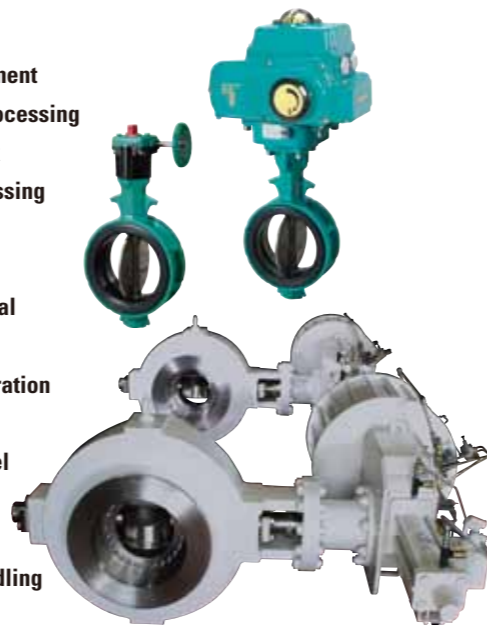

Tomoe's butterfly valves are complying with various global standard.

ISO 9001



※The certification authority : Tomoe Valve Co., Ltd. (Japan)..... JIC
 Shanghai Tomoe Valve Co., Ltd. (China)..... Lloyd's
 Tomoe Valve Limited (UK)..... Lloyd's
 PT. Tomoe Valve Batam (Indonesia)..... Lloyd's

CE MARKING & EC DIRECTIVE



Japan RPS 0160326/01
 0038/PED/20020012/A
 0038/PED/MUM/0410034/2
 UK Directive 97/23/EC
 COV0612767/1/2

Marine approvals

- Nippon Kaiji Kyokai (NK)
 NK 98FV601B NK 94FV601B
 NK 93FV606B NK 93FV601B
 NK 92FV603B NK 05FV601B
 NK 09FV601B NK 10FV604B
- American Bureau of Shipping
 A.B.S 02-Y0230943/2-PDA
 A.B.S 09-Y0490039-PDA
- Bureau Veritas (France)
 02572/GO BV 09498/BO BV
 09499/BO BV
- Lloyd's Register of Shipping
 LR 00/10044 LR 96/10037

※Please consult us regarding the relevant models.

Others

- For fire safety
 - For tap water
-

Tomoe offer the widest range of products available, to meet the increasing demands of global industry

The first products that Tomoe developed were rubber lined butterfly valves. These were supplied to the Shipbuilding and HVAC industries. These products were highly regarded by end users for their high quality and reliability.

The success of these products led to the development of PTFE lined valves, high performance double offset valves, rotary control valves, and triple offset valves, which are gaining increasing popularity on some of the most critical applications within the industry.

Tomoe are committed to ensuring that the most innovative and uniquely designed products are developed through continuous information gathering and understanding of our customers demands.

TRIPLE OFFSET ROTARY PROCESS VALVE

TRITEC (TT1/TT2)

The Tomoe triple offset metal seated butterfly valve with its friction free operation provides wide range ability as well as zero leakage performance, on the most demanding and critical applications.

Triple offset geometry can be used up to 2500LB rating and offers longer operational life.

A double block and bleed dual isolation design is also available to increase the safety of a wide range of process conditions.

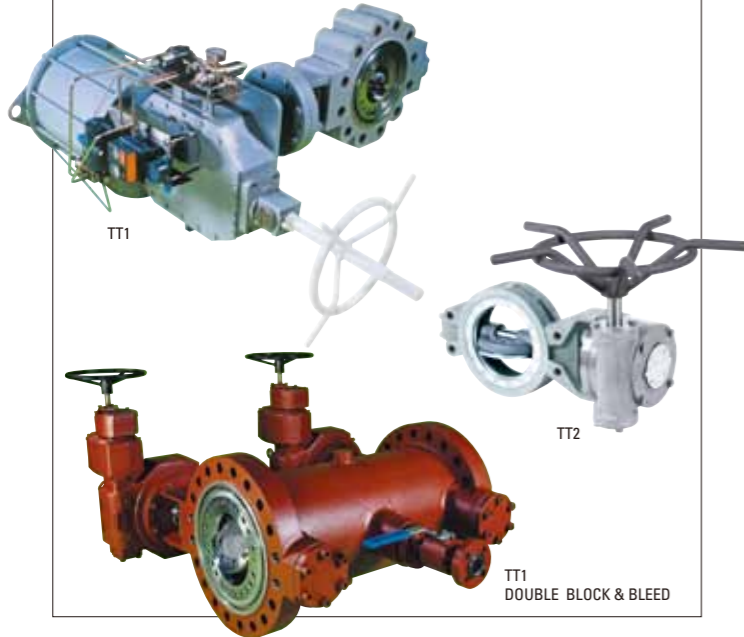

HIGH PERFORMANCE BUTTERFLY VALVE

334A / 302A / 304A / 304M(HLV)

The double offset geometry with its smooth cam style action allows accurate control over the range 10 to 90 degrees of rotation and provides reliable sealing in most applications. The valve can be supplied with R-PTFE or Metal seal options depending on the working pressure & temperature, seat leakages ranging from ANSI/FCI Class IV to VI and API 598 Zero leakage can be supplied.



ROTARY CONTROL VALVE

DTM

The ultimate rotary control valve DTM, provides the end user with highly accurate control under most critical process conditions, including high pressure drop liquid/gas applications. The DTM series can be supplied with or without an integrated cavitation breaker, to reduce noise levels by as much as 30dBA, and exhibits higher anti-cavitation capabilities.



507V / 508V

The anti-cavitation toothed disc is suitable on many critical control applications, where cavitation and noise issues are a problem. This unique disc design will provide the end user with higher control accuracy and noise reduction from up to 5 to 10 dBA.

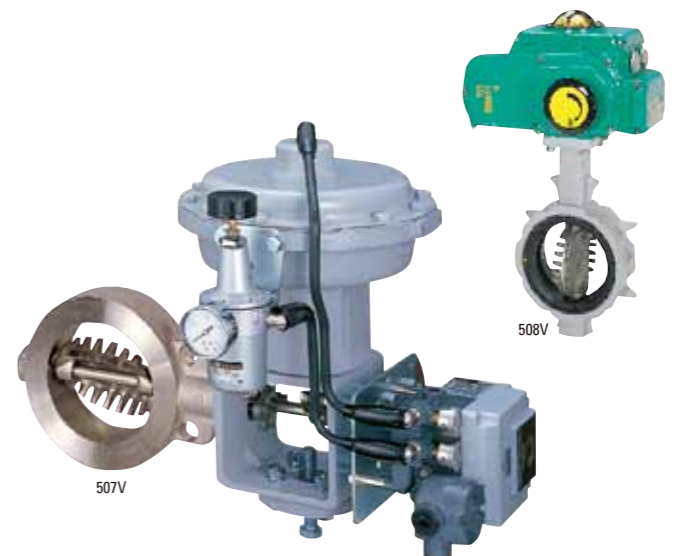
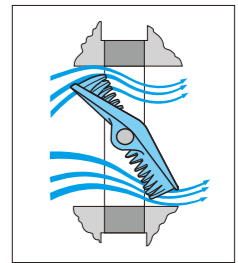

RUBBER LINED VALVES



PTFE LINED VALVES

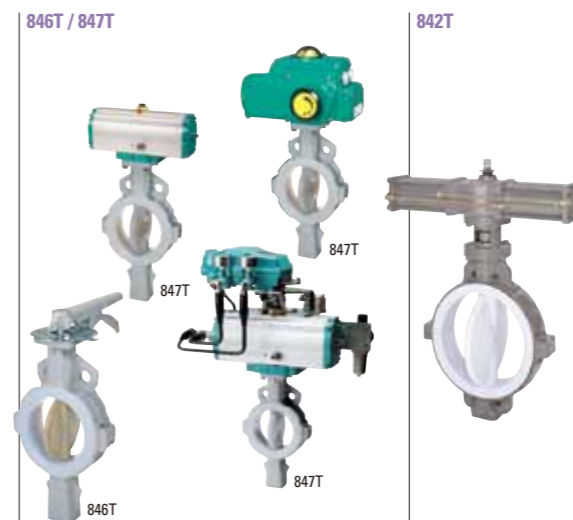

CHECK VALVE

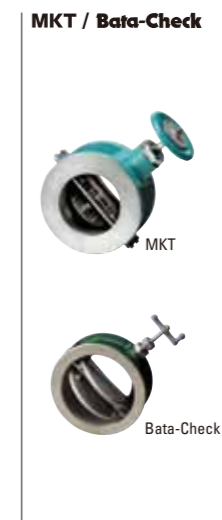

ACTUATORS



STRATEGIC, GLOBAL AND LOCAL RESOURCES

TOMOE's manufacturing, sales and distribution facilities are located strategically throughout the world. It provides industry with a direct link to the most advanced range of products and highest levels of customer support available.



WHEREVER YOU FIND TOMOE IN DAILY USE, YOU FIND A TOTAL COMMITMENT TO PLANT EFFICIENCY AND ENVIRONMENTAL PROTECTION...



DHC and Air Conditioning

In the field of building utilities, TOMOE was the first to develop an aluminium die cast butterfly valve and the latest design with a high performance engineering plastic which prevents dew condensation. It made a breakthrough in space saving and excellent cost performance. The DHC (District Heating and Cooling) System is a centralized heating/cooling system, which supplies a group of buildings in a certain area heated water, steam, cooling water and other energy media generated in one or more heat supply plants. The Tomoe butterfly valve can be used in all areas of these modern systems and as a result they make a huge contribution to the development and comfort of modern day urban life.



Water Treatment & Desalination

Water is a top priority of human life. For keeping rivers and lakes clean, companies are obliged to have their own water treatment equipment that can eliminate all the harmful elements from their waste water. The equipment today has been developed in such a manner that it removes toxic elements not only by using highly refined mechanical and chemical devices, but also by applying frontier technology of biodegradation process. Superb leak tightness and the introduction of advanced materials have enabled TOMOE to become a market leader in this industry, where environmental awareness is at the fore.



Process Industries

Fluid flow lines in steel mills, chemical and pharmaceutical plants, food processing factories, paper mills and many other process industries have their own unique requirements for valves. These include services such as water, gas, steam, powder and granular fluids, both high pressure and high temperature. Tomoe products are well suited for use on all of these applications. Our reputation for high quality and reliability is constantly favored by both plant operators and end users alike.



Power Generation

In response to growing demands for environmental protection against global warming, acid rain, increasing CFC's and pollution, more and more preventive actions are urgently needed. For applications found within environmental protection systems and energy preservation, a butterfly valve should satisfy various severe requirements including control capability under high temperature and pressure conditions. Taking an example of a geothermal power plant, a butterfly valve must withstand coarse sand, pointed fragments of rocks, and other hard debris. As for the flue-gas desulfurization system of a fossil thermal power plant, the butterfly valves applied should be resistant to corrosion and erosion. With their outstanding features and capability, TOMOE butterfly valves are constantly supporting the environmental protection systems and public utilities of today.



Oil & Gas (Onshore & Offshore)

Tomoe Tritec metal seated triple offset butterfly valves are used on both offshore oil and gas platforms for a wide range of process control and isolation duties. They are also widely used at onshore refineries and processing terminals, where the critical nature of these process environments require repeatable tight shut off, long service life and low maintenance. The triple offset butterfly valve is an ideal replacement for the conventional gate and ball valve.



Marine

Like public utilities and offshore plant facilities, TOMOE valves are fully approved for shipboard use by all the leading marine authorities. TOMOE plays an essential role in the heart of the ship, the engine and other critical locations which require a compact and light weight design, as well as constant, accurate and reliable function for safe operation.